

MECHANICAL MODEL

VARIATOR

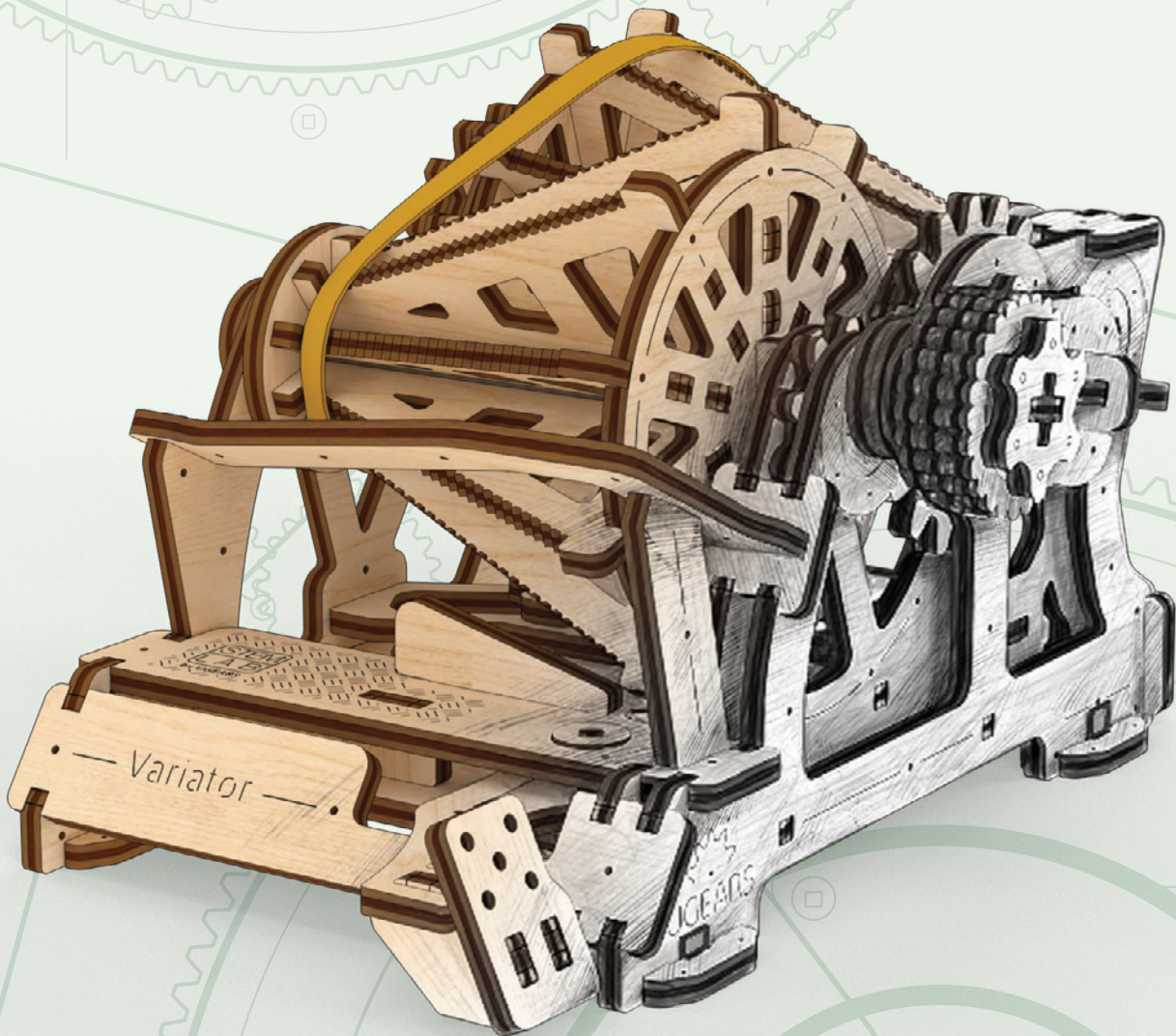

Handbook of A Young Engineer

§1

Introduction

In order to operate properly and efficiently, vehicles with an internal combustion engine need to use a gearbox. This is because engines can operate effectively only in a limited speed range. Engineers and designers try to achieve the best balance of performance, durability, cost, and engine weight, while above all maximizing the system's energy efficiency.

There is a significant limiting factor, however: internal combustion engines only allow you to adjust the output shaft speed across a fairly short range. Engineers therefore use a gearbox, to not only adjust the speed but also to increase the torque (twisting force causing rotation) transmitted to the wheels of the vehicle. The gearbox is essential to achieving the desired wheel speed, without exceeding engine load and while conserving fuel and engine resources.

In addition, a mechanical transmission provides the option of reversing the rotational direction of the output shaft, thereby reversing the vehicle's direction.

Each pair of gears in a transmission provides a certain transmission ratio. As a rule, the gears are combined in groups of two, which makes it possible to engage one gear by moving the gear group in one direction (step up) and to engage another gear by moving in the opposite direction (step back).

In contrast, variators do not have fixed gears, and so provide a smooth ratio variation in transmissions. Reverse capabilities in transmissions with variators are provided by a special unit called a planetary reducer (to learn more about planetary reducers, check out the UGEARS «Curvimeter» STEM model, ugearsmodels.com/curvimeter.html).

Variators are used not only in cars but also in various small-motor equipment—scooters, snowmobiles and quadricycles, machine tools, conveyors, lawnmowers—and other mechanisms.

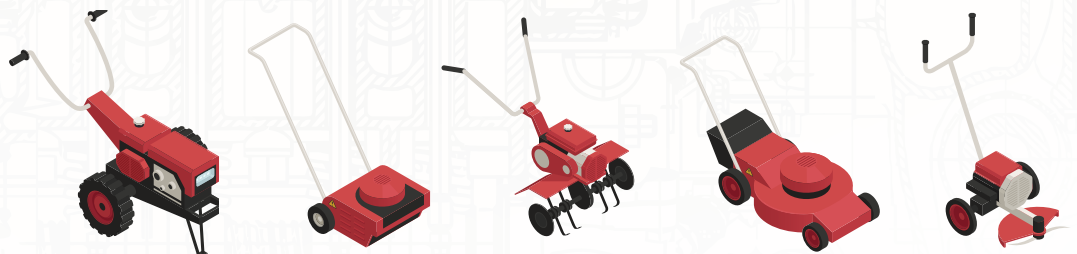

[ugearsmodels.com/
curvimeter.html](https://ugearsmodels.com/curvimeter.html)

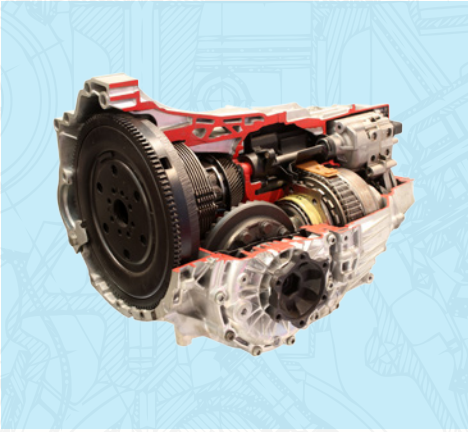

In today's vehicles, so-called automatic transmissions (ATs) are widely used. As technology and engineering evolve, ATs are largely replacing manual transmissions (MTs).

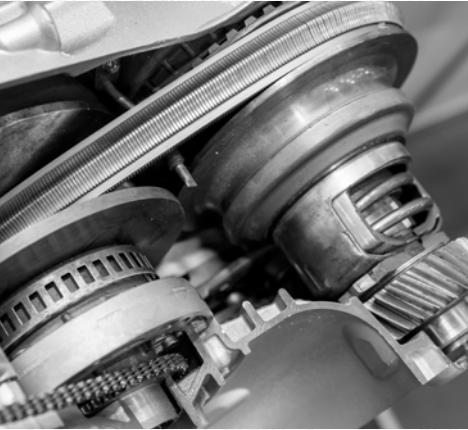

A variator (Latin: variator = «changer») or CVT (continuously variable transmission), which we will explore in detail today, is one type of automatic transmission.

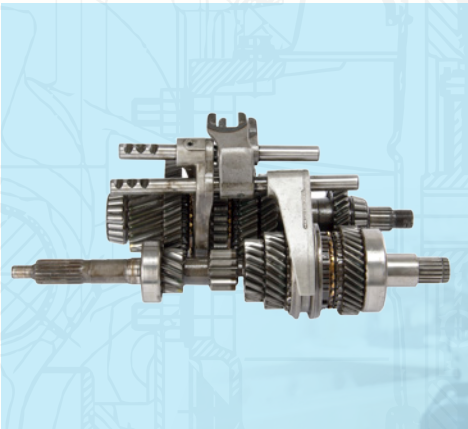

With MTs, the gear ratio is changed stepwise with the help of a gearshift knob, operated by the vehicle's driver. With ATs, gears are changed automatically, without the need for the driver to decide when to shift gears or operate the gearshift. Early ATs, however, retained the disadvantage of stepwise gear shifting. Changing gears in such transmission setups, whether MT or AT, takes time and is accompanied by physical impacts, or wear.

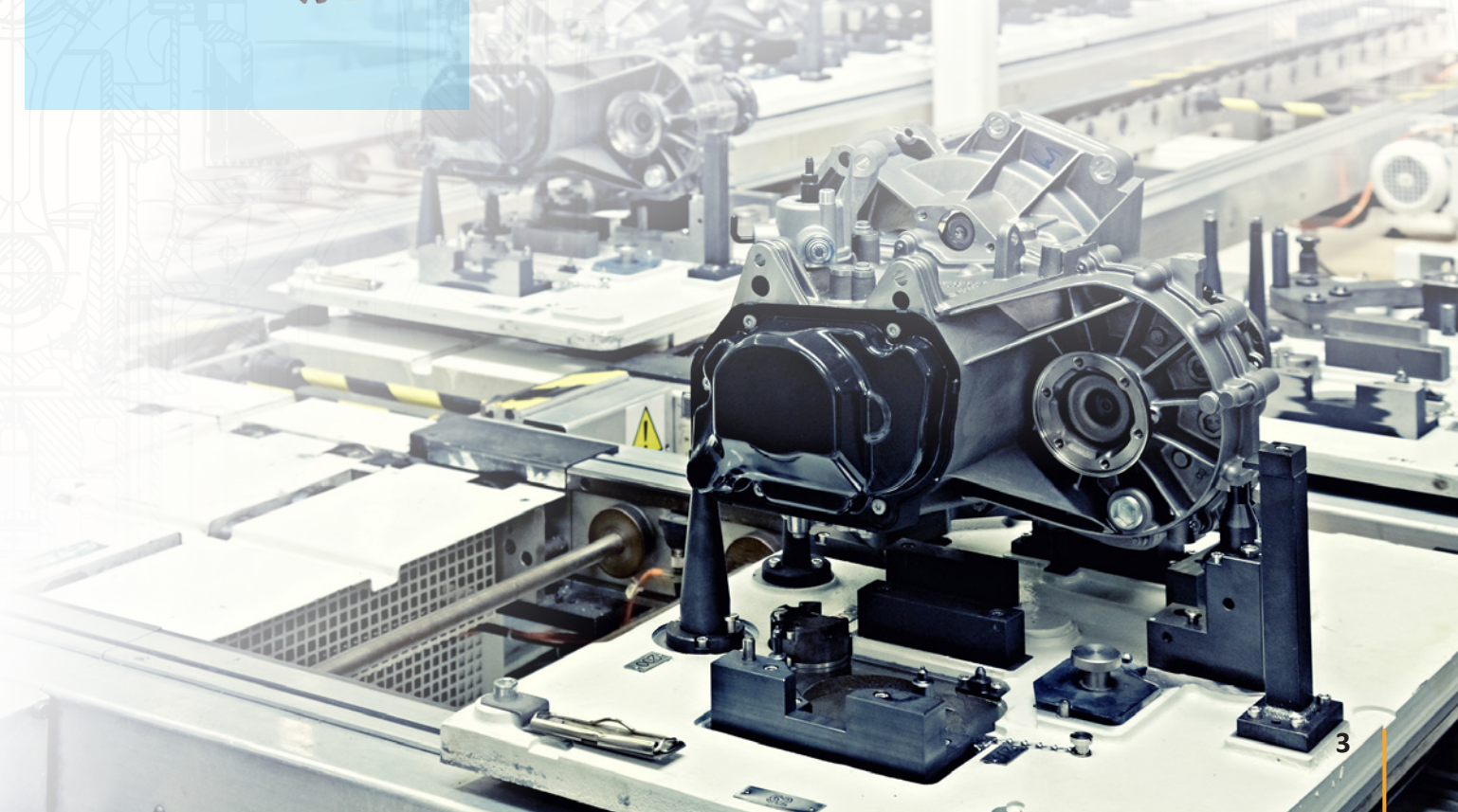

§2

Historical background

Variators have become widespread relatively recently, empowered by new technologies, materials, and process control systems.

The first patent for a variator was issued at the end of the 19th century, but if you look at the Codex Madrid of Leonardo Da Vinci, you will find the first mentions and drawings of variator mechanisms, four centuries before!

Mechanical engineering has developed rapidly in the last few centuries. While mechanical transmissions have been known for a long time, gear, chain, and belt transmissions, as well as more advanced types of transmissions only came into existence in the 20th century.

Mechanical transmissions have been successfully applied in various fields. The advent of automobiles led to many developments and improvements in mechanical transmissions. Vehicles require a mechanical transmission that connects the engine shaft and wheels (in British English, «transmission» refers to the entire drivetrain).

MT gear transmissions allow drivers to change the transmission ratio manually, stepwise, such that wheel speed can be increased (or decreased) while the engine shaft remains at a constant speed.



The desire to create a transmission capable of changing the transmission ratio automatically, without human intervention, led to the development and wide-scale introduction of new types of mechanisms in the automotive industry, one of which is a variator.

At the beginning of the 20th century, variators were primarily used in light equipment such as scooters. In the mid-century (the 1950s) they were widely used in the aviation industry (in electric generators).

The first production car with a variator appeared in 1958 and was called the DAF 600. Its creator, engineer Hubert Van Doorne, founder of the DAF factory, was inspired by a belt transmission used in mechanisms at his factory. This transmission technology was called Variomatic.

Despite the simplicity and low cost of its design, manufacturers were initially skeptical about the new technology.

In 1986, a variator with a metal belt was designed—an approach that is still being improved on.

The metal belt significantly improved the performance characteristics of variators, both in terms of belt life (150,000-200,000 km versus 50,000 km) and allowing their use in transmissions with more powerful motors (up to 200-300 hp).

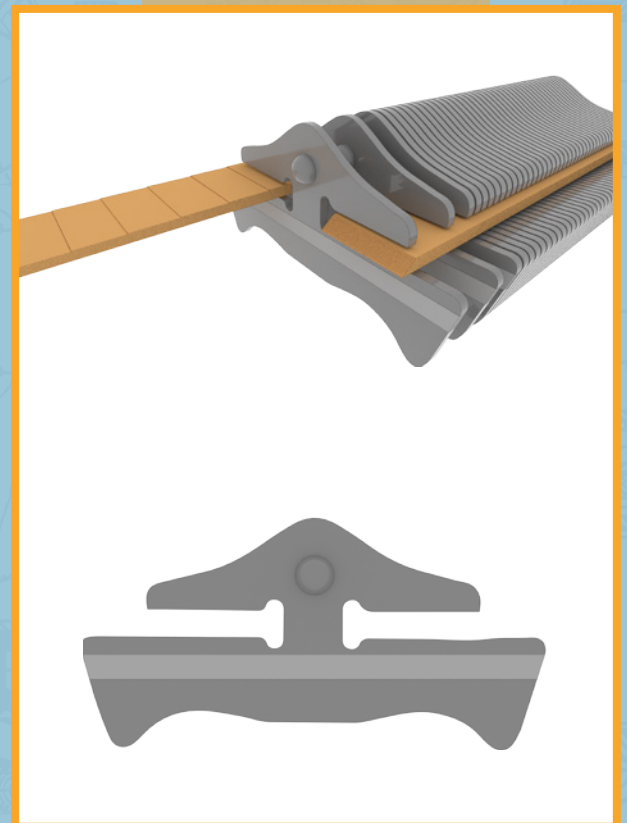
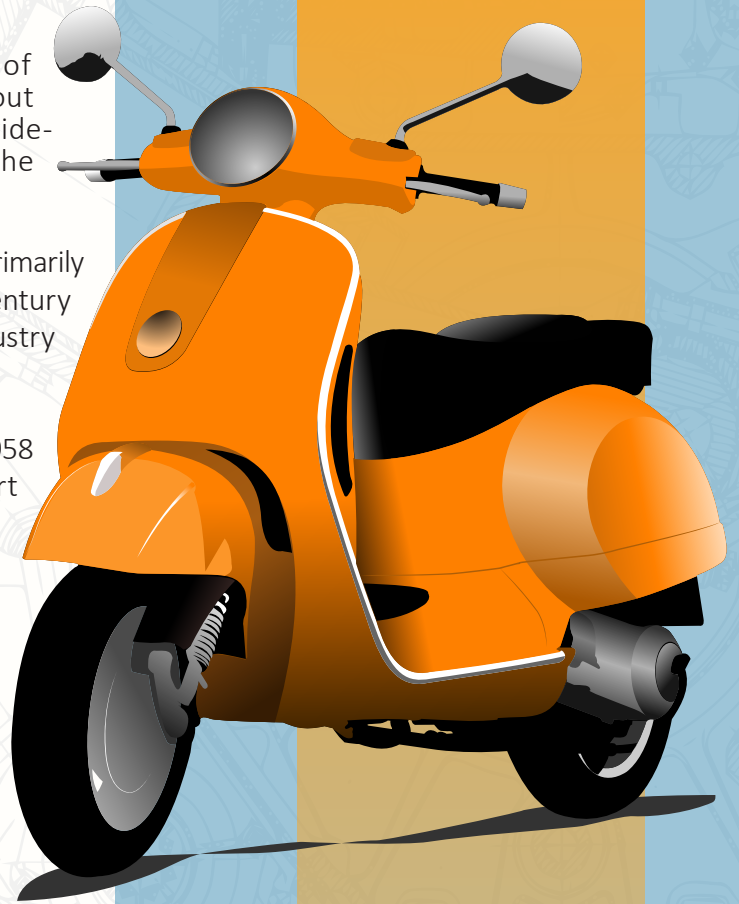

Metal belt variator



1 Scan QR to download App



2 Open the application



3 Point and align the image on the screen with the model

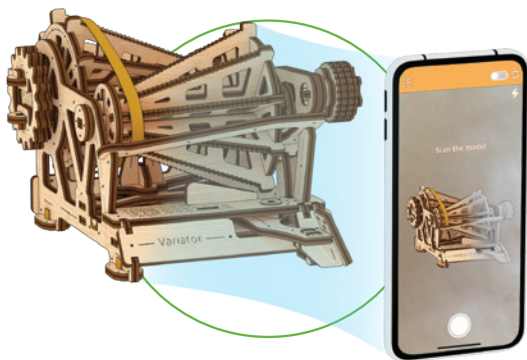

4 Interact in AR

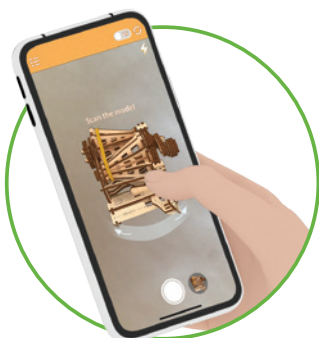

A Ugears STEM-lab mechanical model is an interactive guide to how a mechanism works.

Assemble the VARIATOR, learn its key principles and how it works.

Use Ugears AR application that will take you on a trip to augmented reality. Point the camera of your mobile phone or tablet at the assembled model and discover how the mechanism is used in real life. Interact with the model by changing the viewpoint and angle to see how the Variator works in a car transmission and in a motor scooter.



Enjoy our unlimited support!

Should you have any questions about assembly, we are always here for you to suggest the best solution and provide the help you might need. Our 24/7 customer support service will accept and process your request promptly and professionally.

Customer support:
customerservice@ugearsmodels.com

§3

Variator description and uses

Let's take a closer look at the components and engineering principles of variators.

Variators come in various types: V-belt, chain, and toroidal.

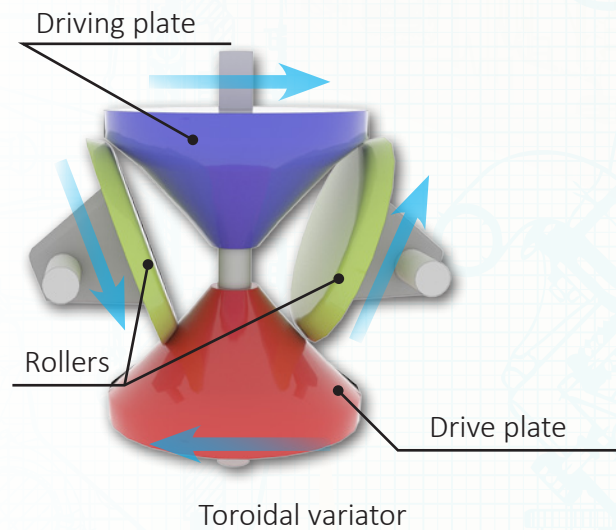
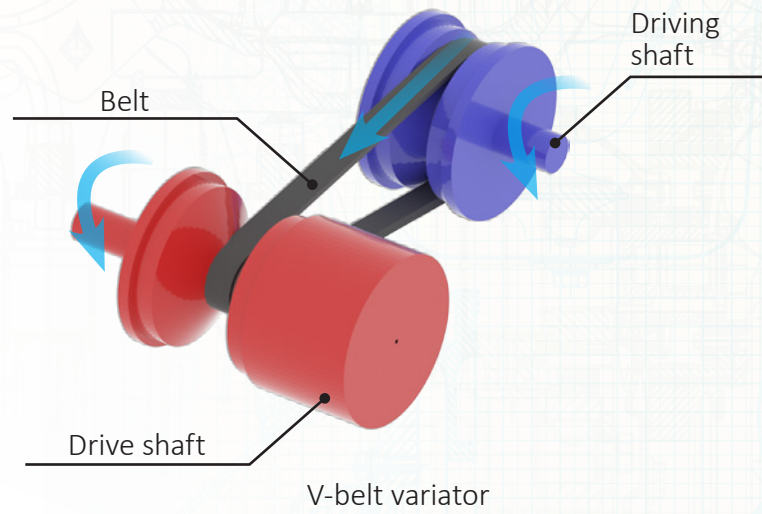
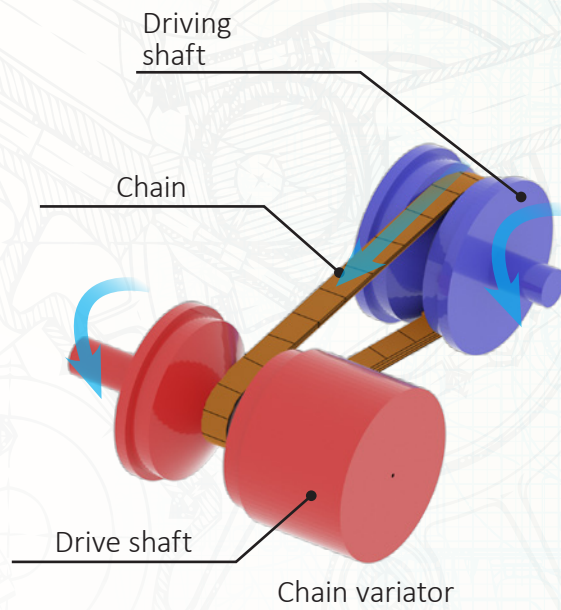

Modern car variators are special belt transmissions. In practice, two variator designs are the most commonly used:

- Friction V-belt variator
- Friction cone variator with belt

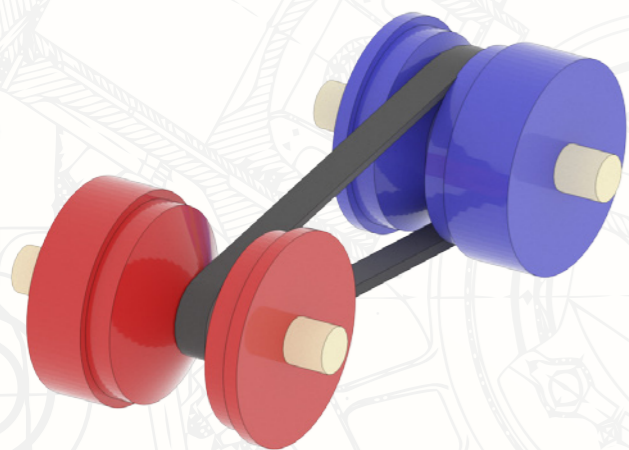

Friction V-belt variator



Friction cone variator with belt

Let's first take a look at the V-belt variator, as it's the most widely-used in the automotive industry. The belt-driven variator is equipped with a belt that is V-shaped (trapezoidal) in cross-section, which solves the slippage problem of flat belts. Each pulley consists of two movable sidewalls.

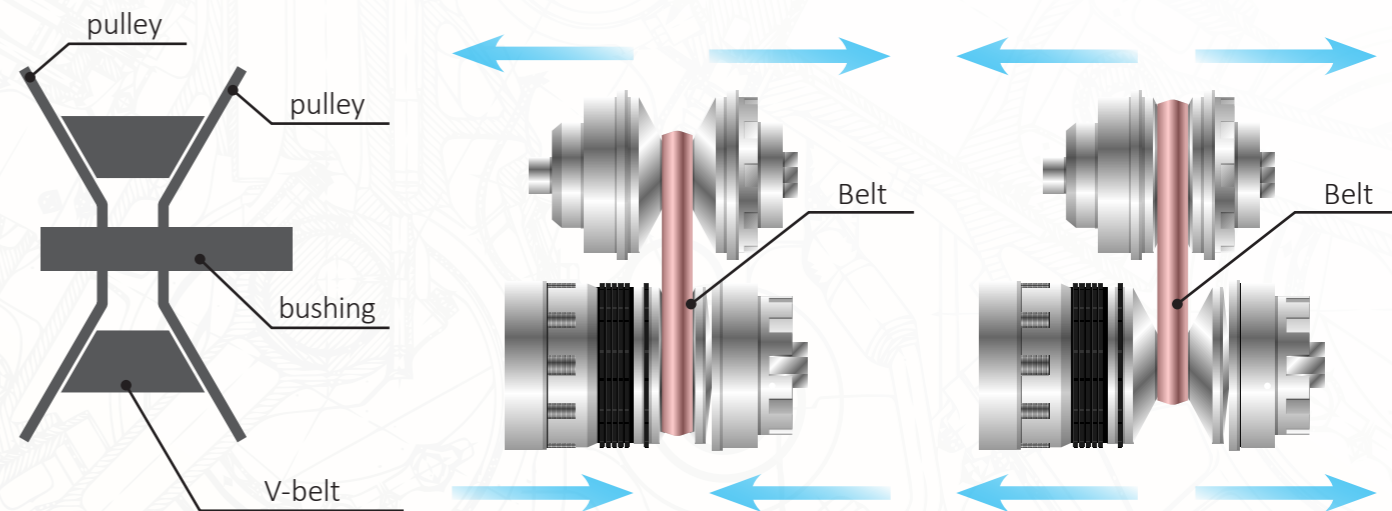

V-BELT VARIATOR

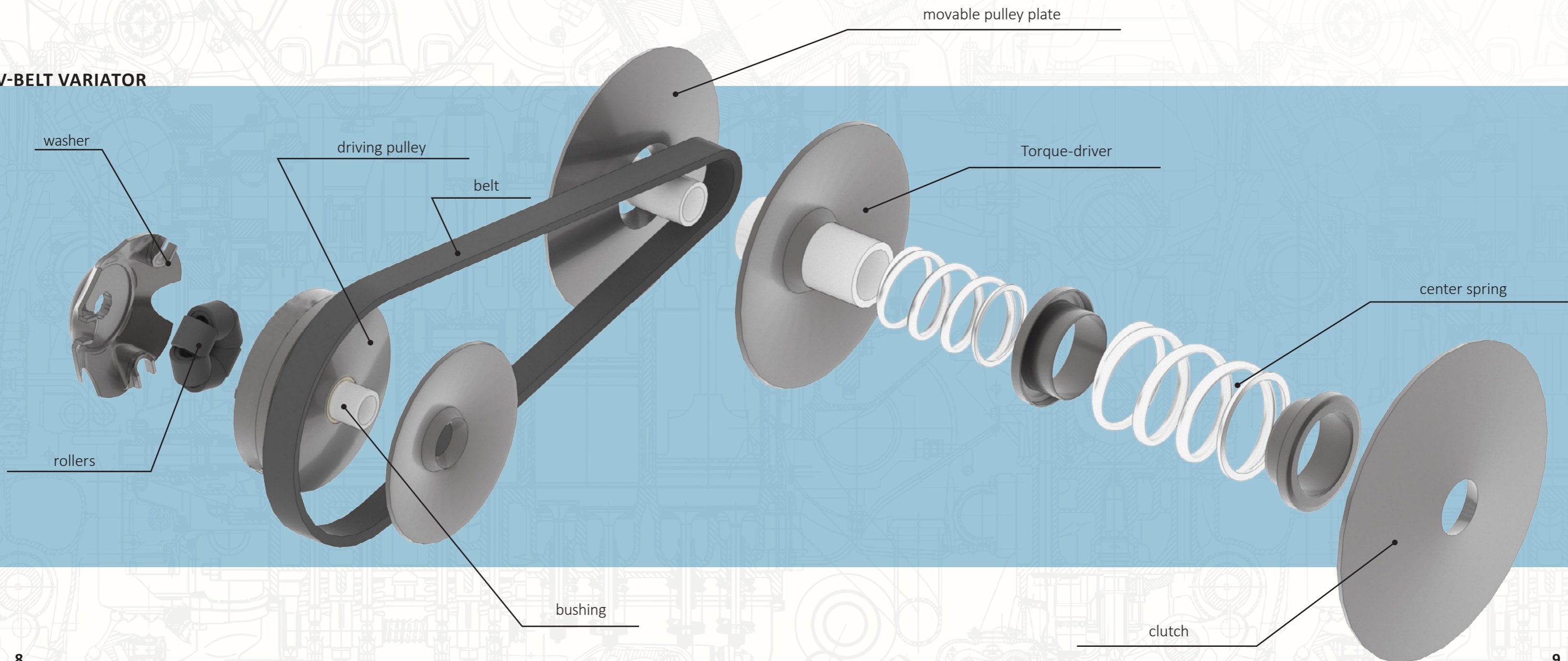

The pulley's two adjacent sidewalls together form a cone-shaped gap (groove). In this design, the driving pulley is connected to the engine shaft, and the torque from the driveshaft is transmitted to the wheels of the vehicle.

The distance between the sidewalls of each pulley can be changed using an external control system. The control system maintains the required belt tension. This is critical, as the frictional force is what is being transmitted, and belt slippage wears the pulleys.

As the gap between sidewalls is expanded, the belt moves closer to the axis of rotation of the pulley, and therefore travels around a smaller-diameter circle. Conversely, when the sidewalls are brought closer together, the belt moves away from the axis of rotation to travel around a larger-diameter circle.

By changing the radius of the belt around the driving and driven pulleys, you can smoothly change the transmission ratio.

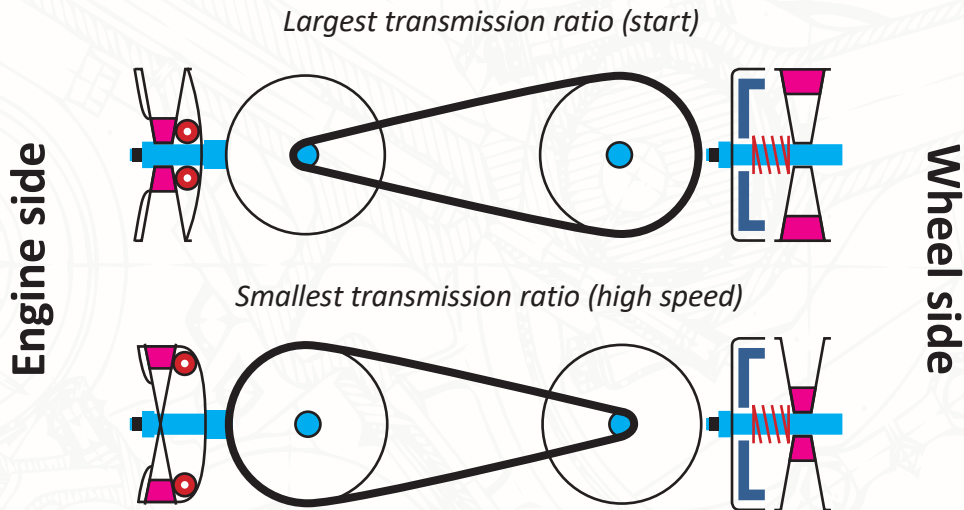

In other words, a belt «variator» can be described as a belt transmission with pulleys, the diameters of which can vary. When increasing the diameter of one of the pulleys, the control system simultaneously decreases the diameter of the other pulley, to maintain correct belt tension. Thus, the transmission ratio of the belt variator changes as the belt shifts position.

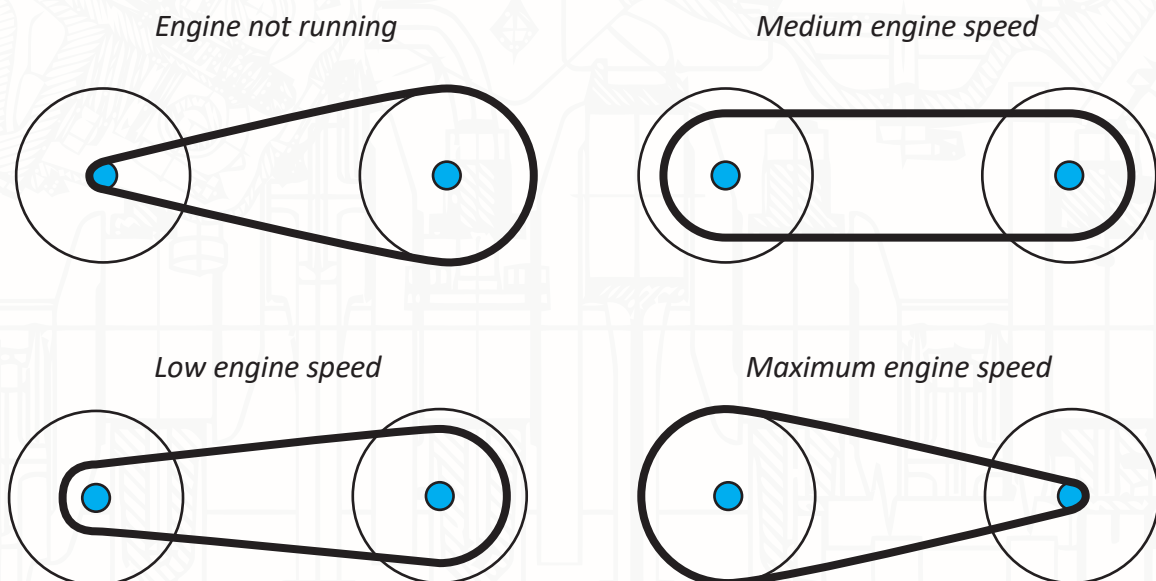

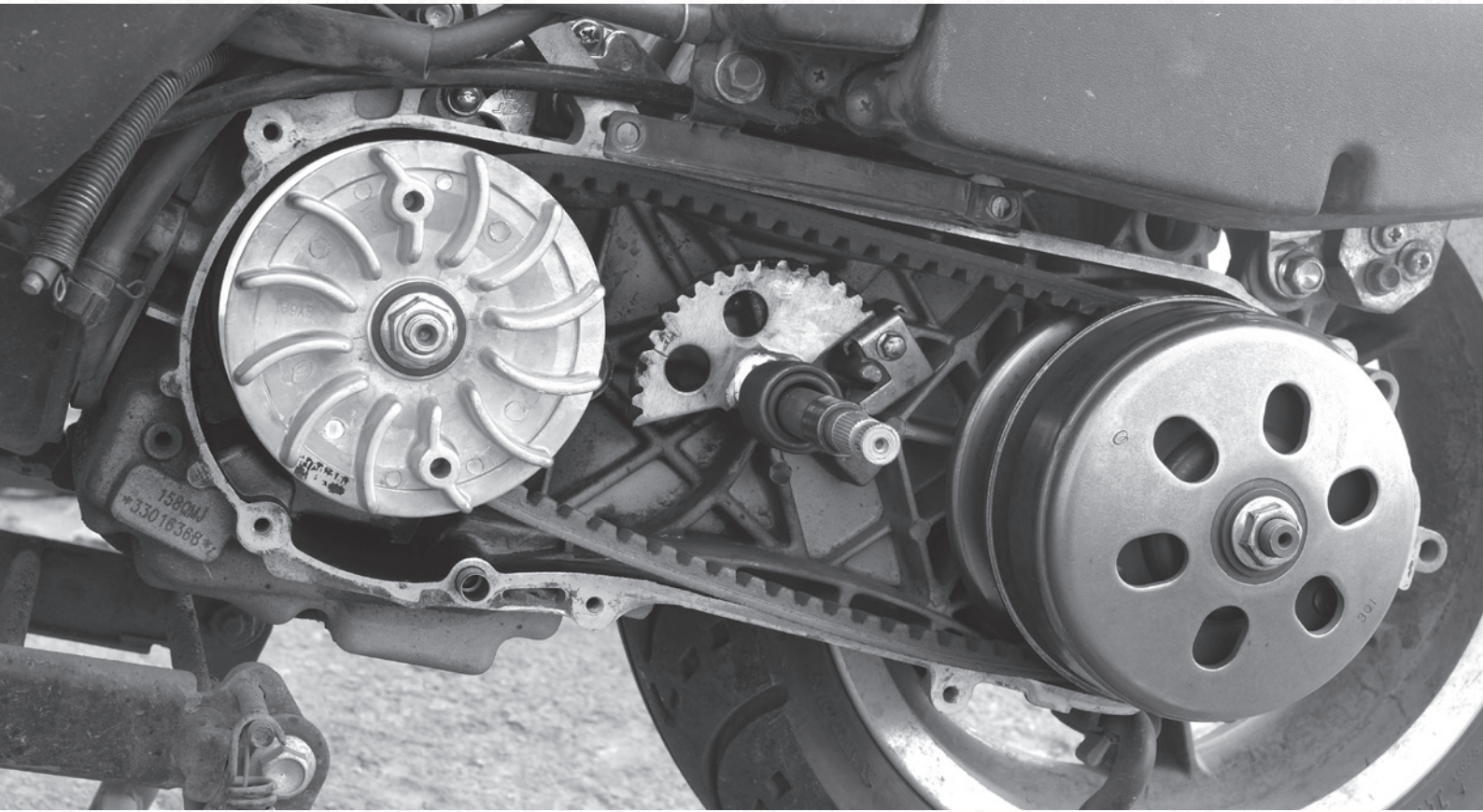

As you can see, a change in the effective diameter of the pulleys will lead to a change in the transmission ratio, and hence a change in wheel speed. The variator provides most of the features of a manual transmission, including regulating the speed of the output shaft (drive wheels) and the torque delivered to the output shaft (moment of force). But the advantage of the variator is it can do this without any bumps! Transmission ratios are changed quickly and smoothly, without the need for shifting. Changes in transmission ratio are fully automated.

This simplifies your driving—a factor that, along with simplicity and low cost, makes the use of variators in scooters popular.

Check it out!

The «Gearbox» 3D puzzle from UGEARS' STEM Lab series—a model that fully shows the operational principles of a manual gearbox—will help you visualize and understand the basic principles of a manual transmission.

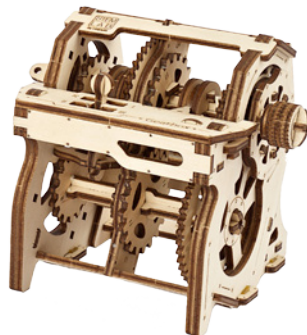

§4

The physics and mechanical principles behind the “Variator” STEM model

As discussed above, variators are widely used in cars and various other mechanisms. They are mechanical transmissions, and their transmission ratio is changed by an external control system.

The overwhelming majority of variators are **special belt transmissions**. These are more complex mechanical transmissions, equipped with an additional control system that allows for changing the transmission ratio in various ways, e.g., by changing the geometry of the pulleys or by moving the belt.

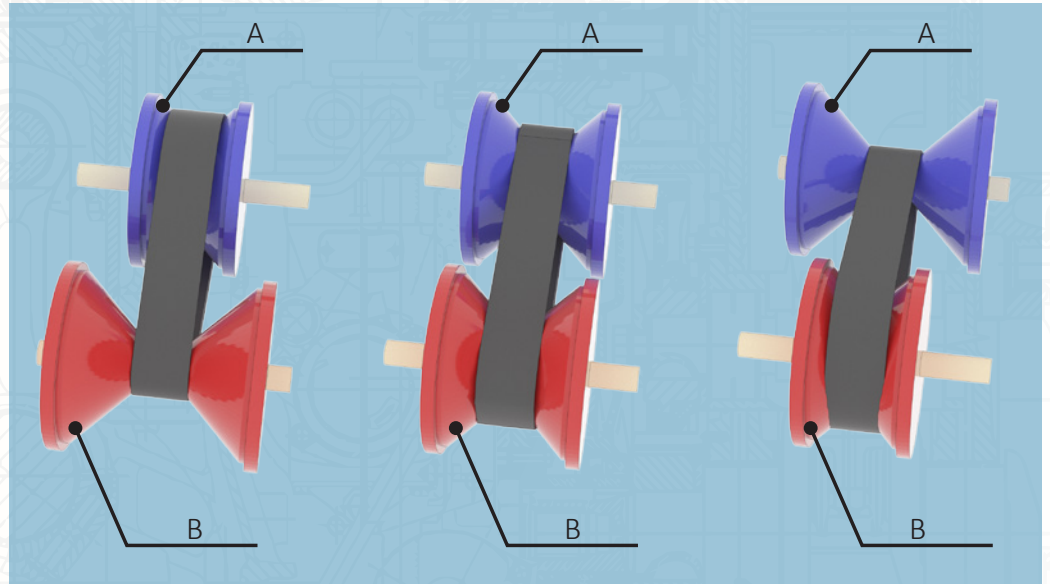

A transmission ratio formula can also be used for variators. The diameters D_A and D_B in this formula will not be constant, but variables:

$$i = \frac{n_A}{n_B} = \frac{D_B}{D_A}$$

Let’s take a look at a simple belt transmission. It consists of two plates (or pulleys) that rotate. The figure shows Pulleys A and B, the diameters of which are D_A and D_B .

In this example, Pulley A is on the driving shaft and Pulley B is on the driven shaft. The pulleys are mechanically connected using a special flexible belt that wraps around the pulleys and is tensioned.

The frictional force of the belt on the pulleys is transmitted, such that when Pulley A rotates, Pulley B rotates too. This transmission can only happen when the belt is tensioned.

A belt transmission is similar to a gear transmission, but unlike a gear transmission, a belt can transmit the force over long distances.

The moment of force (torque) (p 15) is a widely used variable for levers, wheels, and other rotating parts of mechanisms.

 A gear transmission solves the problem of how to change the moment of force and speed of rotation of the output shaft, while allowing the engine to spin at its optimal rate (input shaft). The gear pairs between shafts in the transmission can be of different diameters. When a large gear with high torque and low rotational speed is paired with a smaller gear, a small torque and high rotational speed are obtained on the second gear shaft, and vice-versa.

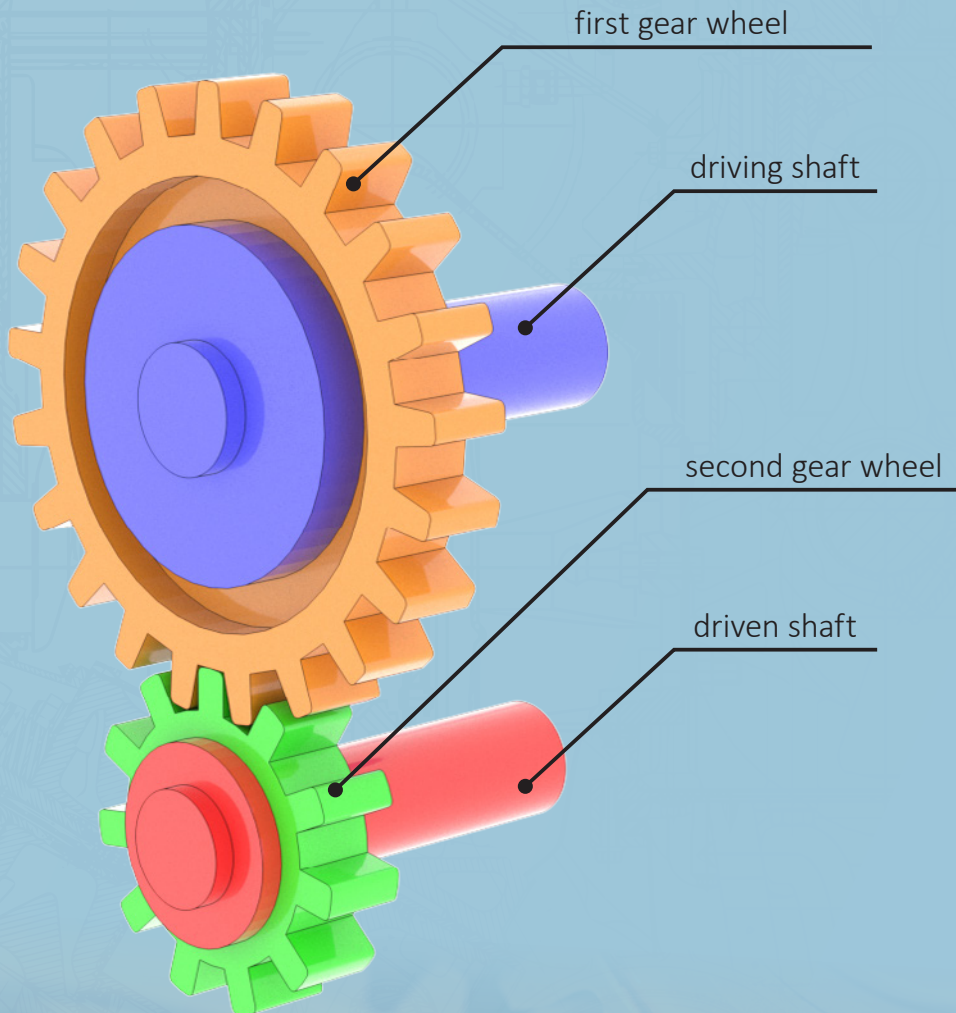

The basic engineering concept is that an input or driving shaft (driven by the engine) has fixed gears which engage with other gears fixed to a countershaft, which in turn interacts with fixed gears on the output shaft. This output or driven shaft must overcome external resistance (for example, make the wheels of a vehicle rotate).

The most important parameter of mechanical transmissions is the transmission ratio, which is the ratio of the rotational speeds of the driving shaft and the driven shaft,

$$i_{12} = \frac{n_1}{n_2}$$

where the rotational speed is the number of revolutions that each of the shafts makes per minute (n_1 is for the first shaft and n_2 is for the second). In accordance with the law of conservation of energy, an increase in speed will correspond to a decrease in torque.

In the illustration, one of the wheels (the large pulley) rotates slowly, but a large moment of force is applied to its shaft. The smaller pulley has a higher rotational speed, but a low moment of force on the shaft.

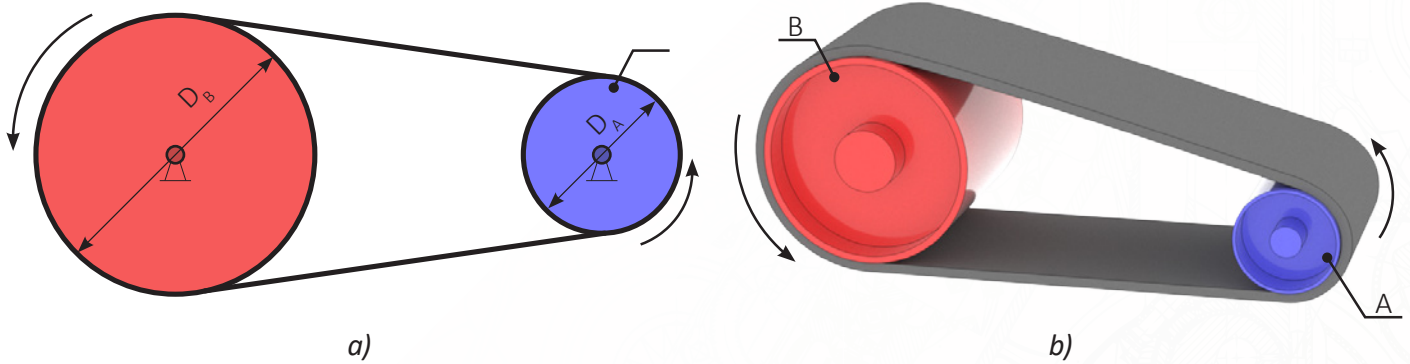

Moment of force is a value equal to the product of force per arm. In the simplest case (see Fig.), the moment of force acting on a body is equal to the force in Newtons multiplied by the distance from the axis of rotation to the point of application of the force in meters. According to the example, the moment M is found by the formula:

$$D = F * L.$$

In the example, the shoulder is the distance from the axis of rotation to the point of application of the force (i.e., a point on the surface of the pulley).

The gear ratio of a belt transmission shows changes in speed (increases or decreases) as well as corresponding changes in the moment of force.

$$i = \frac{n_A}{n_B} = \frac{D_B}{D_A}$$

*Note that the gear ratio shows the ratio of the rotational speeds of the pulleys. The larger pulley will rotate at lower speed relative to the smaller pulley; therefore, in this case, the gear ratio is greater than 1.

As you can see from the description and illustrations, the same rotating wheel will create different forces depending on the distance between the point of application of the force and the axis of rotation of the wheel.

The following pattern is used for the moments of force acting on the body; in order for the body to be in equilibrium, the sum of the moments of all the forces that act on it must equal zero.

According to Newton’s law, two equal but opposite forces acting on a body balance each other.



A Newton (F) is a unit of force—a physical quantity that determines how much one body affects another. For example, we often talk about how strong we are, but what we really mean is how much we can affect other things. Force is measured in Newtons.

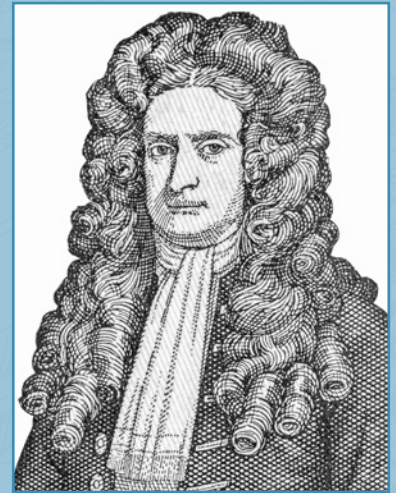

Torque is the product (multiplication) of a force by the distance of the lever arm (measured from the axis to the point where force is applied). Force is expressed in Newtons while lever distance is expressed in meters or feet (for example, the length of a wrench). Accordingly, $1 \text{ N} * 1 \text{ m} = 1 \text{ Nm}$. 1 Nm equals a force of 1 N (Newton) applied to a 1-meter lever.

In internal combustion engines, force comes from the fuel that ignites in the cylinder then to the crankshaft assembly, and to the crank shaft. The crank shaft engaging with the transmission system rotates the wheels.

Torque is not a constant. It will increase with a stronger force applied to the lever arm and vice versa. If the driver pushed the acceleration pedal, the force applied to the lever grows as well as the moment of force.

A lever is a rigid body that can rotate around a fixed support. A wrench is a good example of a lever. To unscrew a nut, you fix one end of the wrench to the nut, then apply counterclockwise force to the other end—this is the fundamental design of a lever.

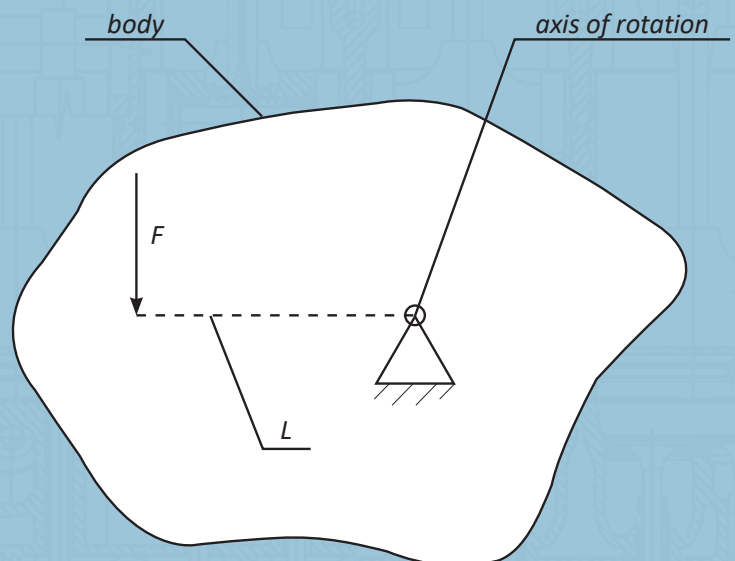
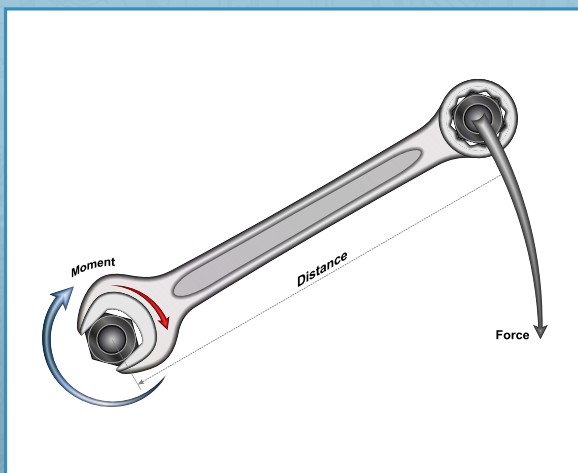

§5

Mechanical UGEARS Variator



The Mechanical UGEARS variator follows the design of a friction cone variator with a belt, unlike the V-belt variator described above. A cone belt variator embodies the same principles, but the geometry of its pulleys does not change.

The pulleys are cone-shaped, and it is the belt that moves (using a special lever that shifts the belt along the cones). The belt is made of elastic material. When the belt shifts to the larger diameter side of the first cone, it will simultaneously shift to the smaller diameter side of the second cone (see Fig.). This workflow is equivalent to the workflow of a V-belt variator.

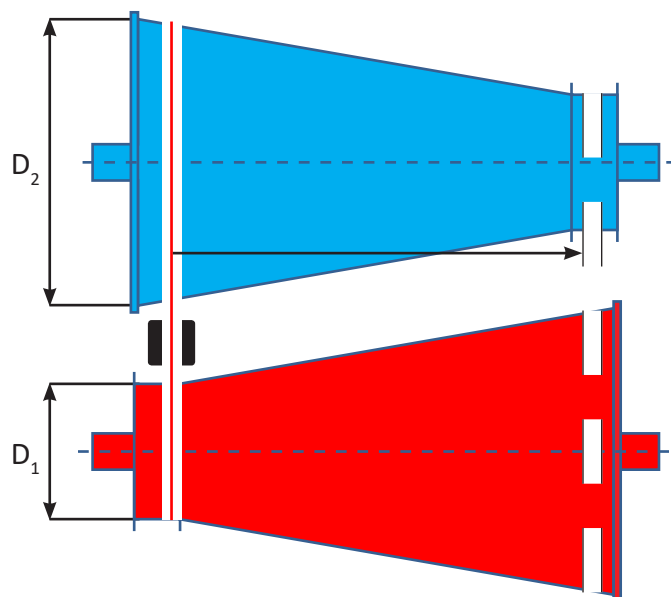

Friction cone variator with a belt

Let's take a closer look at the design of the UGEARS Variator, as well as the process involved in changing its transmission ratio.

The variator has a driving cone, which is rotated manually by means of a handle (via an additional gear transmission), and a driven cone to which the rotation is transmitted. A belt made of elastic material is wrapped over the two cones and transfers mechanical energy as a result of frictional forces. The device is equipped with a lever that allows the belt to be shifted, thereby changing the transmission ratio (see Fig.).

The two cones are the same size. Their axes of rotation are parallel, but their vertices are facing in opposite directions. Thus, the end of the first (driving) cone with maximum diameter is placed opposite the end of the second (driven) cone with minimum diameter.

In this model, the maximum diameter of the cone is 65 mm, and the minimum is 25 mm (the ratio of these values is 2.6). Remember that the variator can be considered a conventional belt transmission with variable pulley diameters. If actual pulleys were used (instead of cones), the movable sidewalls of the pulleys would create diameters ranging from 25 mm to 65 mm.



We will use the following notations for the variator:

n_A – rotational speed of the driving cone

D_A – current value of the driving cone diameter

n_B – rotational speed of the driven cone

D_B – current value of the driven cone diameter

Changing the gear ratio with the UGEARS Variator

In the position shown in the accompanying Figure 1, the belt has been positioned with a lever in the middle of the cones. In this position, the diameters of both cones are equal at the point underneath the belt. Let's find the transmission ratio:

$$i = \frac{n_A}{n_B} = \frac{D_B}{D_A}$$

According to the above formula, as the diameters are equal, the transmission ratio is 1.

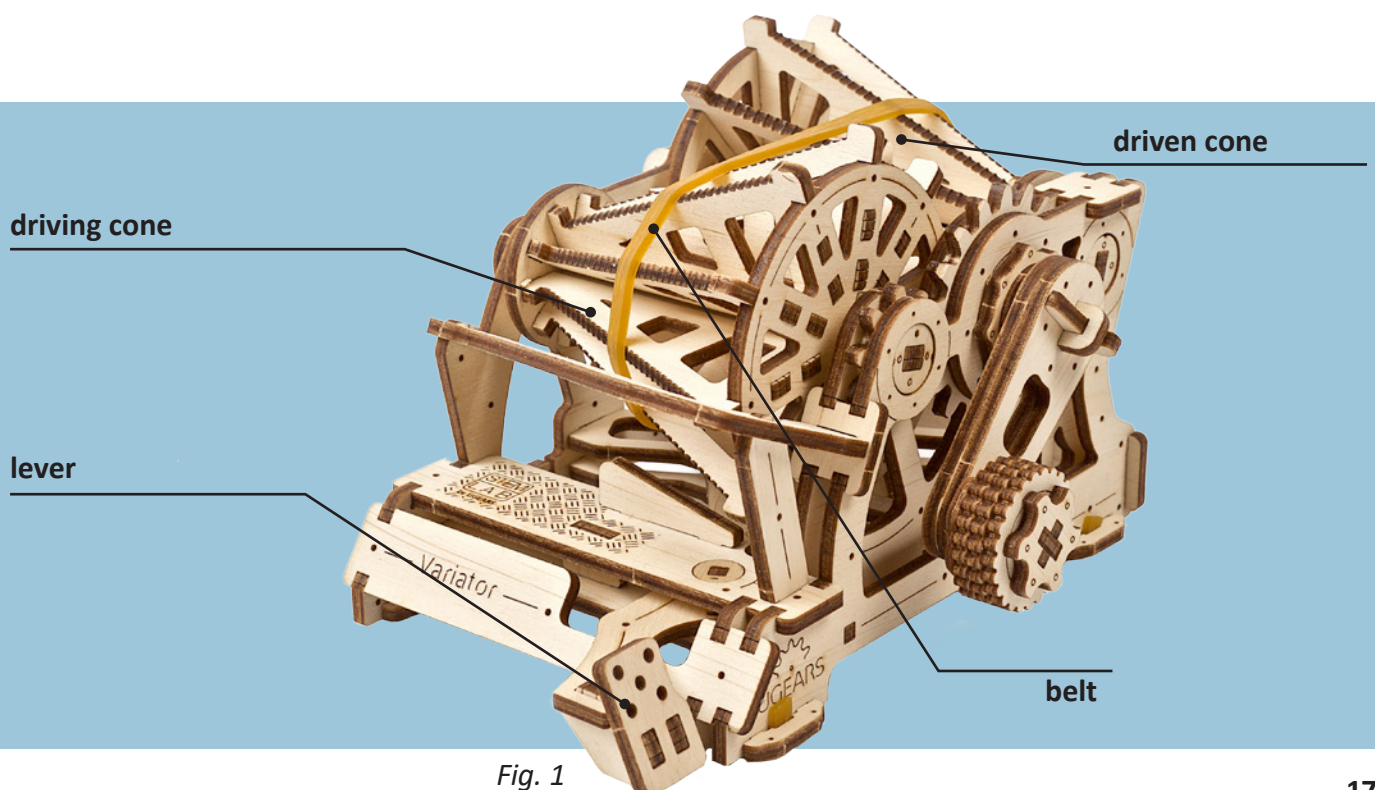

Fig. 1

In the next example (Figure 2), the belt is in the extreme right position, so $D_A = 25$ mm for the driving cone, and $D_B = 65$ mm for the driven one. The transmission ratio is thus:

$$i = \frac{n_A}{n_B} = \frac{D_B}{D_A} = 2.6$$

With the belt in this position, the transmission will be a reducer.

Mechanical transmissions are divided into reducers and multipliers. Reducers transfer the total mechanical energy from the driving shaft to the driven shaft, but because speed is reduced, torque is increased. Multipliers similarly transfer all the mechanical energy from the driving shaft to the driven shaft, but with an increase in speed and a corresponding reduction in torque.

In our example, the transmission decreases the speed ($n_A > n_B$). The smaller diameter driving cone rotates 2.6 times faster than the larger diameter driven one. In other words, while the driving cone makes 2.6 revolutions, the driven one makes 1 revolution.

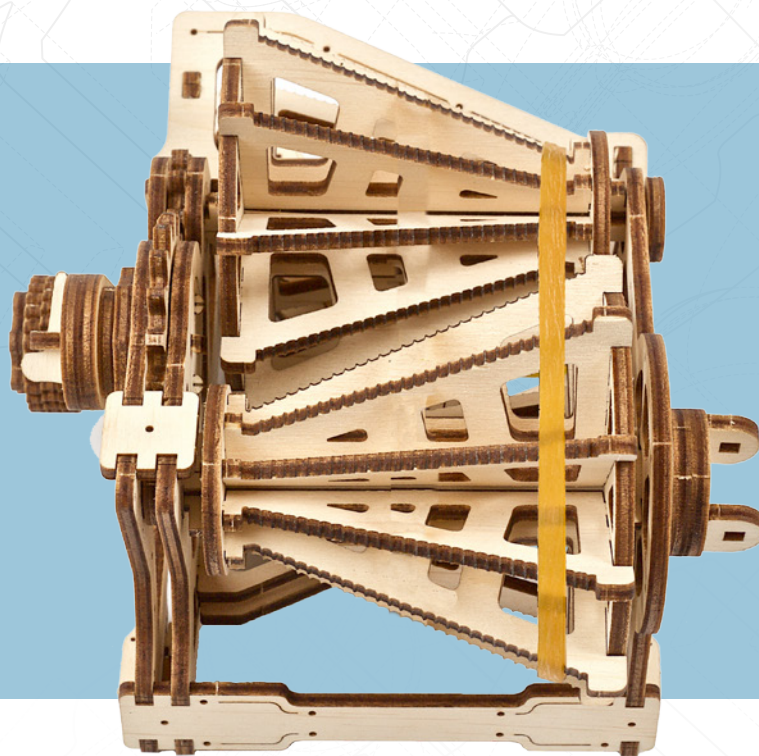

Fig. 2

If you place the belt in the opposite position (in the extreme left position along the cones in the Figure), the transmission will be from large-diameter cone to small-diameter cone, increasing the speed while correspondingly decreasing the torque ($n_A < n_B$).

In this position, the transmission ratio will be 0.38, and 1 revolution of the driving cone will correspond to 2.6 revolutions of the driven cone.

You can use the lever to place the belt at any intermediate position (neither central nor extreme), and then calculate the transmission ratio by measuring the respective diameters of the belt on each cone. You can check the correctness of the calculations performed by making 1 revolution of the driving cone and evaluating the number of revolutions made by the driven cone.

§6

Practical tasks

1. What does the moment of force equal?

- a) force divided by arm
- b) force multiplied by arm
- c) value of the fluctuating force at a given time

2. What does transmission ratio mean?

- a) ratio of the rotational speeds of the driving shaft and the driven shaft
- b) rotational speed of the driven shaft
- c) ratio of the diameters of the primary and secondary pulleys

3. Which of the following transmission ratios provides an increase in the output speed?

- a) 2
- b) 1
- c) 0.5

4. What is the difference between a variator and a conventional belt transmission?

- a) a variator contains a belt of variable length
- b) a variator allows you to stepwise change the transmission ratio
- c) a variator allows you to smoothly change the transmission ratio

Congratulations! You made it!

Thank you for being with us in this adventure, we hope you had fun and learned a thing or two!